

CNC Sign Module



Activity 1:

What is CNC?

Video: Click on the link in grandmanan.org and watch the Activity 1 video.

List 5 things you learned from this video.

Activity 2: Materials

Prepare the 10 1/2" X 18" cedar board

- You don't have any lumber the right width! **What will you do?**
 - How many pieces of the lumber available would have to be side by side to get the width you need?
 - Cut the lumber 18" long. How many pieces are required to equal 10 1/2" width? **Each member of the group requires a piece of wood**

Activity 3: Preparing the material

We need wood the correct width (or a little wider)

- Glue the edges of each board
- Clamp the boards together
- Pipe clamps on edges and bar clamp with support on tops/bottom. (Notice the tape on the supports to prevent glue from sticking to the wood.

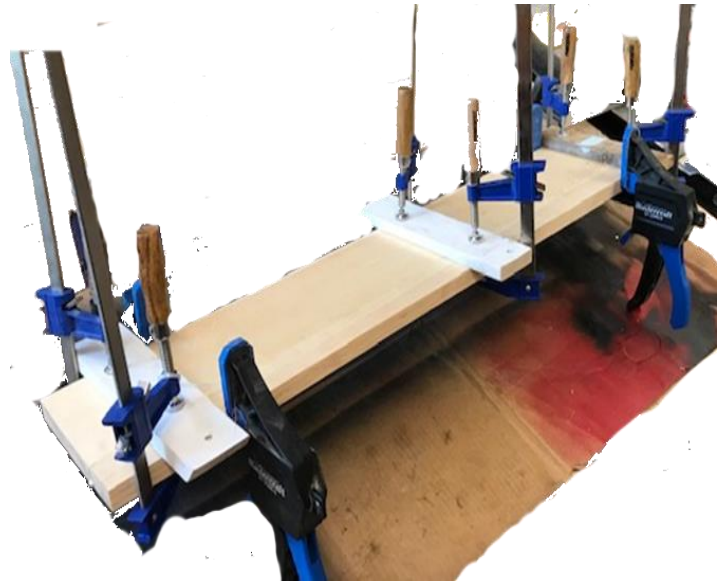

Activity 4: Cutting to size

- When the glue is dry, we need to cut the wood to the right length (use the compound miter saw) and to width (use the table saw): 10 1/2" X 18" (see the instructor before doing this step)
- Run your wood through the planer when the glue is dry to get perfectly smooth boards (see the instructor before doing this step)

Check Yourself: Do your wood glued, planed smooth, with even ends and correct measurements? 10 1/2" x 18"

Activity 5: CNC

Mount the wood on your CNC:

- Use a pencil to draw a line from one corner of the wood to the opposite corner. Do again from the other two corners. Where it meets is the center of the board.
- Line your center mark up with the center on the guide board on the CNC machine.
- Use the clamps to hold down the material as shown in the photo



Activity 6: Carbide Create

Program the text on your sign

- Open **Carbide Creates** software (on your desktop)
- Open the file called **“Sign”**. (Download it from grandmanan.org)
- Double click on the word **“Name”**. It will turn orange and open the **“Create Text”** screen.
- In place of the word **“Name”**, put in your pet’s name.
- Choose one of these fonts (because they fit best):
 - Arial narrow Italic
 - Tw Cen MT Condenses – Regular
 - Gloucester MT Extra Condenses – Regular
 - Bodoni MT - Condensed
- Click **“Apply”** to see how it looks. Click **“Done”**
- Center your words on the board. Click the **“Align Vectors”** icon as shown.

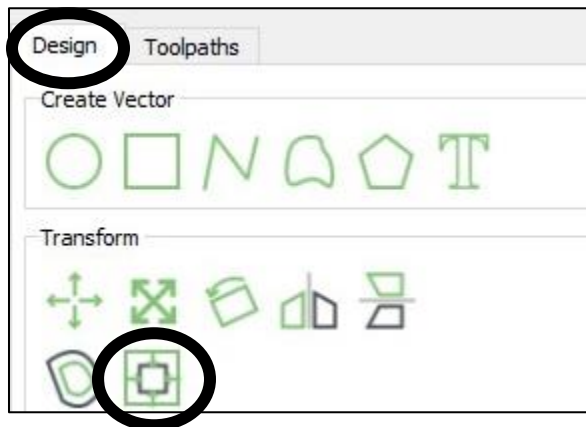
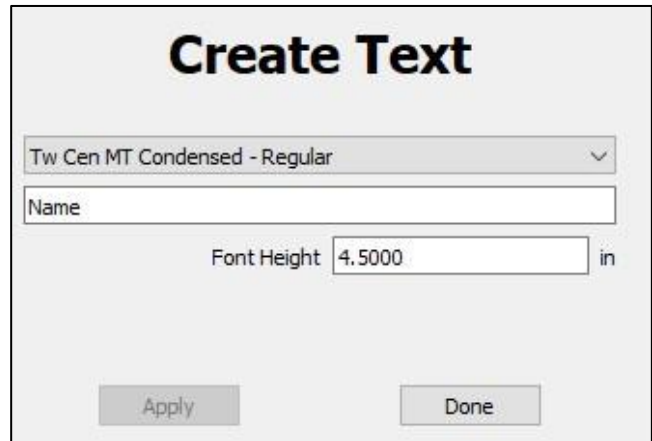
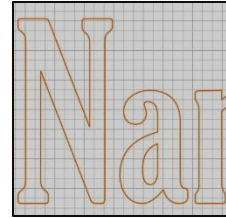

- Click the **“align Center”** option as shown. Click **“Done”**

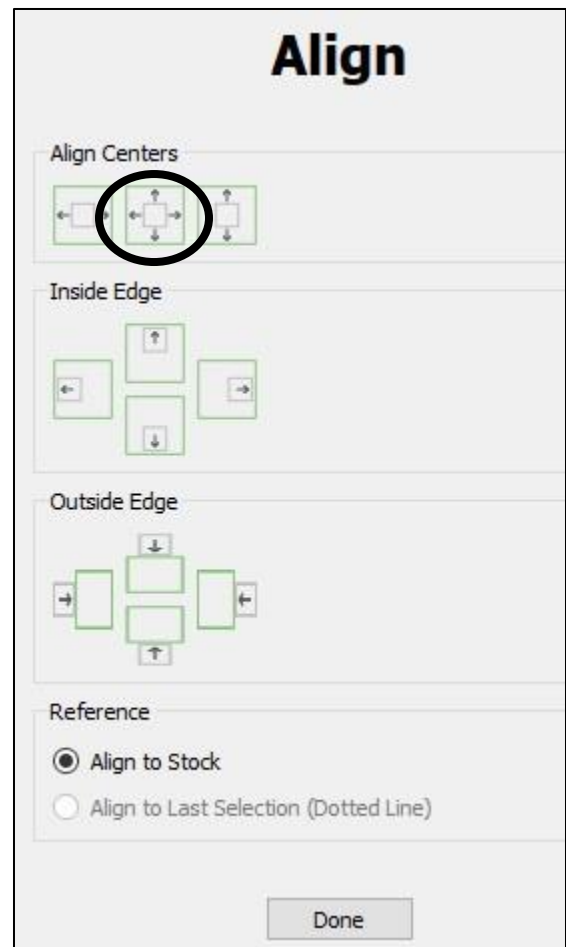

- Click the “**Toolpath**” tab (as shown)
- This should already be set up for:
 - #301 V-Carve 90 degree Tool
 - Maximum Depth

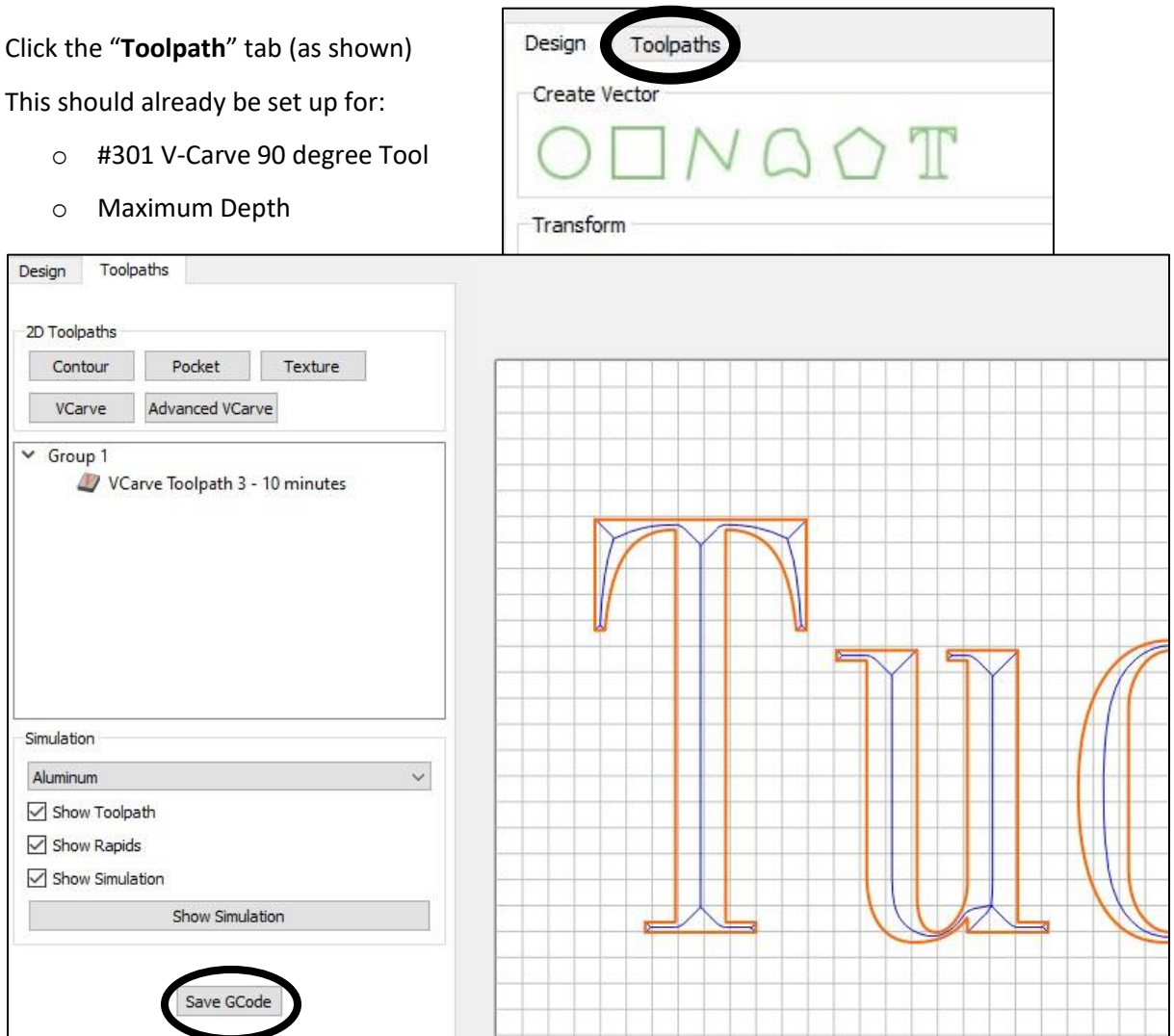

- Click “Save G-Code”. (save it so you can find it)
- Exit this program

Step 5c: CNC

Finding Zero:

- Open Carbide Motion software (on your desktop)
- Turn on the CNC
 - Power bar – turn it on
 - Push the button on the front right corner of the CNC – it will light up blue
- Click **“Connect To Cutter”**, then click **“Initialize Machine”**

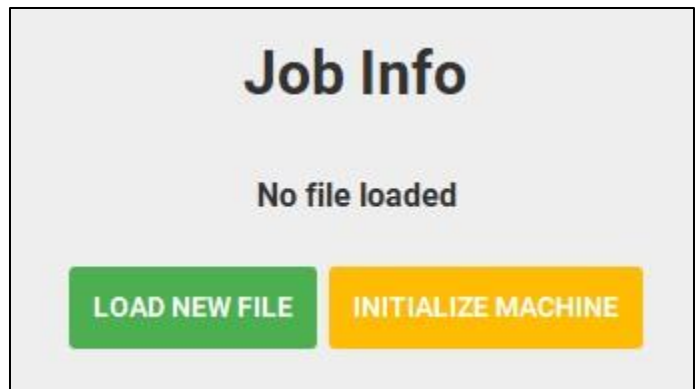
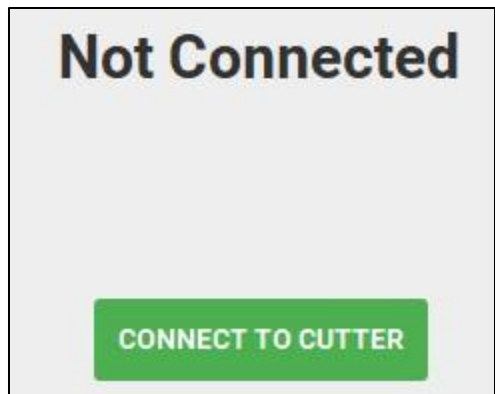

- Click **“Rapid Position”** and click the **“S”** for South. The CNC head will move towards your wood. Click **“Done”**

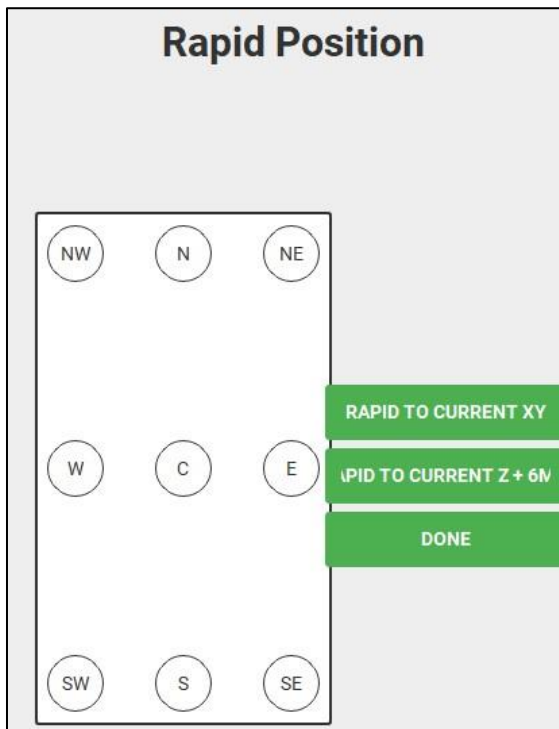

- Click the “Jog” menu. Change the Increment” to “fast”



- Click “Z –” to bring your tip down to the wood. Place some paper between the tip and the wood. If the tip is too low, the paper won’t move.
- Click the “X” and “Y” button to get the tip centered on your center mark. Adjust the increments back to “0.025” to make small moves.
- Click “Set Zero” (Very Important!)



- Click **“Start Job”**
- Click **“Resume”** for each of the warning boxes that appear.

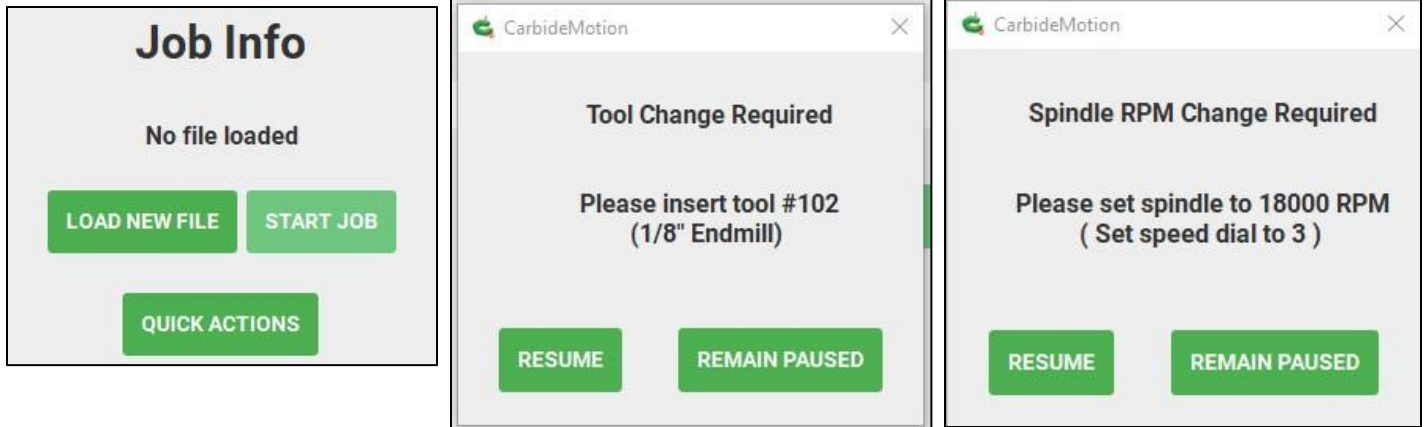

- Turn the Router Power Switch to ON (the spindle will make noise)
- Click **“Start”**

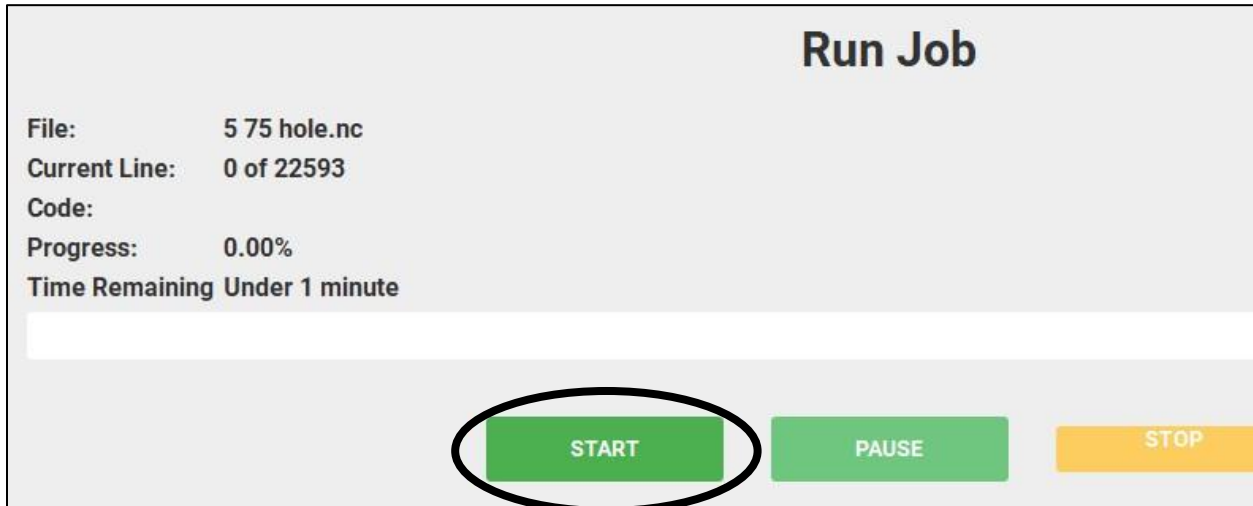

Safety Warning:

If there are any issues/problems. Turn the power switch off!

Step 6: Paint

It's time to paint your letters so they stand out. Ask the instructor which paint to use. Use a small brush or an air brush. Any paint that runs over will just be sanded off after it dries.



Step 7: Router the Legs

- A rounded edge looks better than a 90 degree corner
- Put the appropriate bit in the desktop router (as your instructor how to do this) – **Safety: always unplug the router before changing bits)**
- Router all 4 corners of the 2" X 2" material for the legs – **(Ask your instructor before using the Router)**
- **Safety:** use the feed block and a push stick to keep your hands away from the bit.

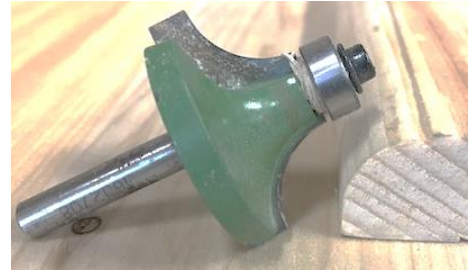

Step 8:

Pocket Hole Screws – a great way to hide fasteners (screws).

- Use a special “jig” so every one is perfect
- They have a pan head with a flat bottom.
- Fine threads are best for hardwood.
- Coarse Threads are best for softwood and plywood.

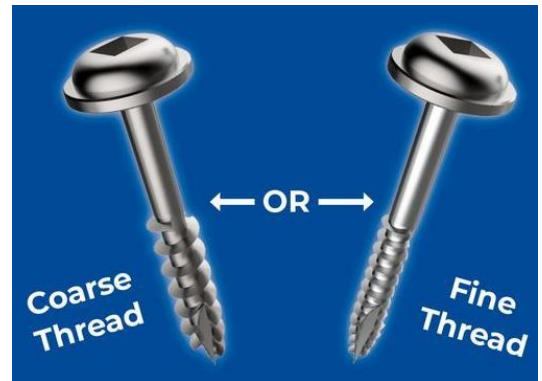

Procedure: (Let's practice)

1. Get **two** pieces of practice wood from your instructor
2. Set up the “jig” and the Bit for your wood thickness (might be already done)
3. Clamp the “jig” to your wood so the guide is at the end of the board

4. Use the special drill bit. Go all the way in until you hit the stop on the drill bit. Drill a second hole.
5. Use the special "hex" bit to screw in the screws. (The "Pockets" should always be hidden on the inside.
6. Your results should look like the photo (right). **Show the instructor!**



Step :

Drill the pocket holes in 4 boards as follows:

- 16" boards – 2 pocket holes on each end, and **TWO** facing upward somewhere in the middle (to hold the top on)
- 7" boards – 2 pocket holes on each end, and **ONE** facing upward somewhere in the middle (to hold the top on)
- Line the board up with the inside of the leg and screw from the inside outward.
- Is it square? When you place it on a flat surface, do all 4 legs sit flat? **If not, stop and make adjustments.**

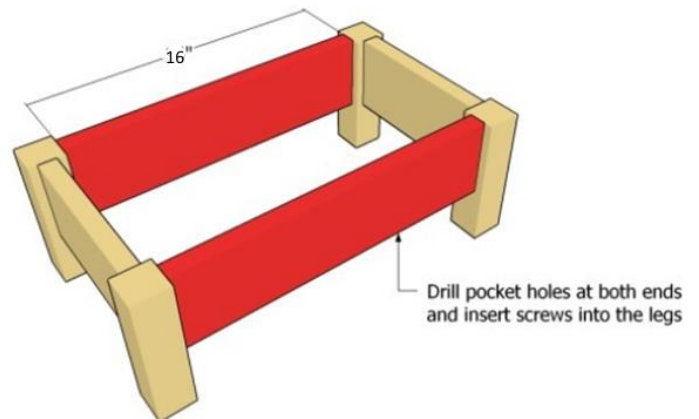
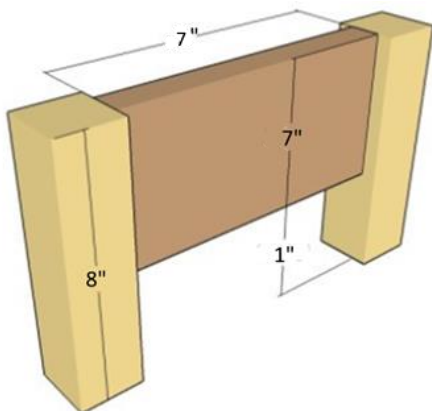



Step :

Plan to cut the holes for the bowls.

1. Use a pencil to draw a line from one corner of the wood to the opposite corner. Do again from the other two corners. Where it meets is the center of the board.
- 2.



Step :

Step : Installing the top

- Turn the top upside down on the bench. Put the frame (legs/supports) on it.
- Make sure the top sits evenly all the way around (equal distance on all sides). Use a pencil to mark that location incase something moves.
- Use the pocket screws to secure the frame to the top. Check one more time to make sure the top is centered.

